KIT PART NUMBER 1600004
INSTRUCTIONS FOR INSTALLING UPDATED
NEW VISION STYLING TRIM FOR 160/173 MERCHANDISERS

CHECK THE PARTS RECEIVED IN THIS KIT WITH THE PARTS LIST IN THESE INSTRUCTIONS. IF ANY PARTS ARE MISSING CONTACT THE CRANE MERCHANDISING SYSTEMS' PARTS DEPARTMENT AT 1-800-621-7278.

Read these instructions carefully before installing the kit.
Keep these instructions for part numbers and for future reference.

THIS KIT CONTAINS THE FOLLOWING:

PART NUMBER	DESCRIPTION	QTY
1592068	TRIM - DOOR - INSIDE - GPL - BLACK	2
1602040	PANEL - TOP TRIM - FLAT "T" BLACK	1
G1472028	SCREW - SHEET METAL - #6 X .44 PHILLPS	12
2222031	TEE BOLT - TRIM	5
1572060	TEE BOLT - TRIM-#6-32 X 3/8	5
9900078	NUT #6-32 KEPS ZINC PLATE	5
9900081	NUT #8-32 KEPS ZINC PLATE	5
1600003	KIT INSTRUCTIONS - INSTALL NEW VISION STYLING TRIM	1

!WARNING! Electrical Shock Hazard - Turn machine off before installing this kit. Failure to do so could result in electrical shock.

1. Read these instructions carefully *before* installing this kit.
2. Remove the Left Side PosiVend emitter board and bracket assembly.
3. Remove the left side glass retaining plate by removing six hex head screws.
4. Drill six 5/32" holes on the inside of the door weld (refer to Figure 3 on page 3).
5. Mount trim piece (1592068) to the outside of the door using 6 screws (G1472028).
6. Replace the left side glass retaining plate.
7. Replace the PosiVend emitter board and bracket assembly.
8. Remove the Right Side PosiVend receiver board and bracket assembly.
9. Remove the right side long glass retainer (1572020) by removing 6 screws.
10. Drill six 5/32" holes on the inside of the door weld assembly.
11. Using six screws (G1472028) mount trim piece (1592068) to the outside of the door.
12. Replace the right side long glass retainer (1572020).
13. Replace the PosiVend receiver board and bracket assembly.

-
14. Disconnect the light fixture harness.
 15. Remove 5 carriage bolts (1306140) and nuts and remove the light fixture.
 16. Remove the top New Vision decal and discard.
 17. Place the 5 large "T" bolts (2222031) in the bottom slot of the top trim panel.
 18. Place the 5 small "T" bolts (1572060) in the top slot of the trim panel.

NOTE: The top and bottom of trim panel (1602040) can be identified by the size of the edge channel on the trim panel. The larger edge channel is the bottom and the smaller edge channel is the top of the trim panel (see figure below).

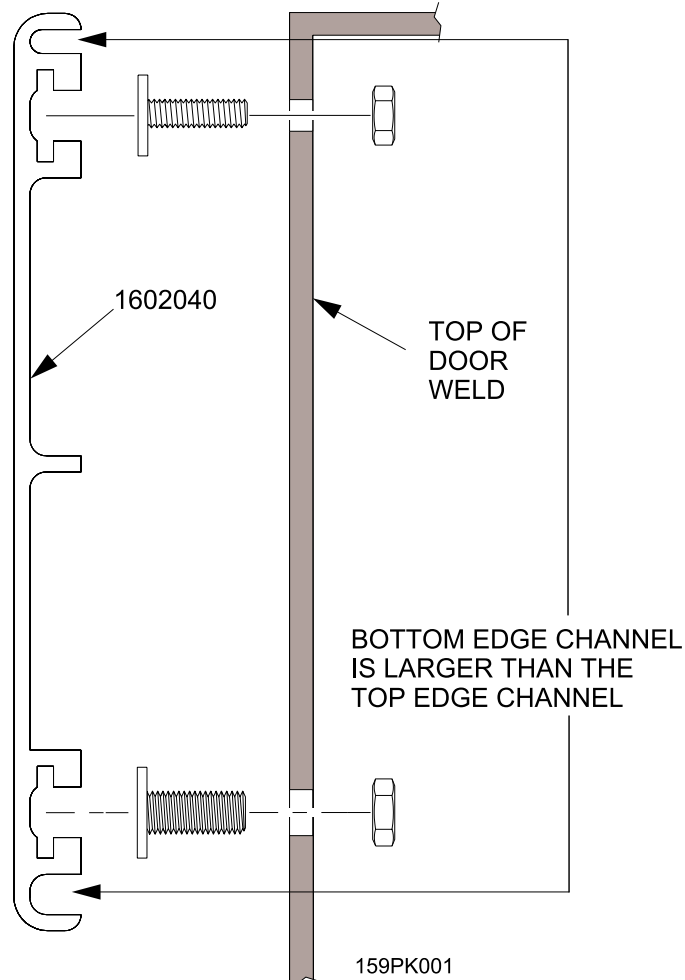

19. Space the "T" bolts in the trim panel and fit the panel to the top of door.
20. With the "T" bolts in the proper holes in the door top, replace the light fixture using large (9900081) and small (9900078) lock nuts.
21. Reconnect the light fixture harness.

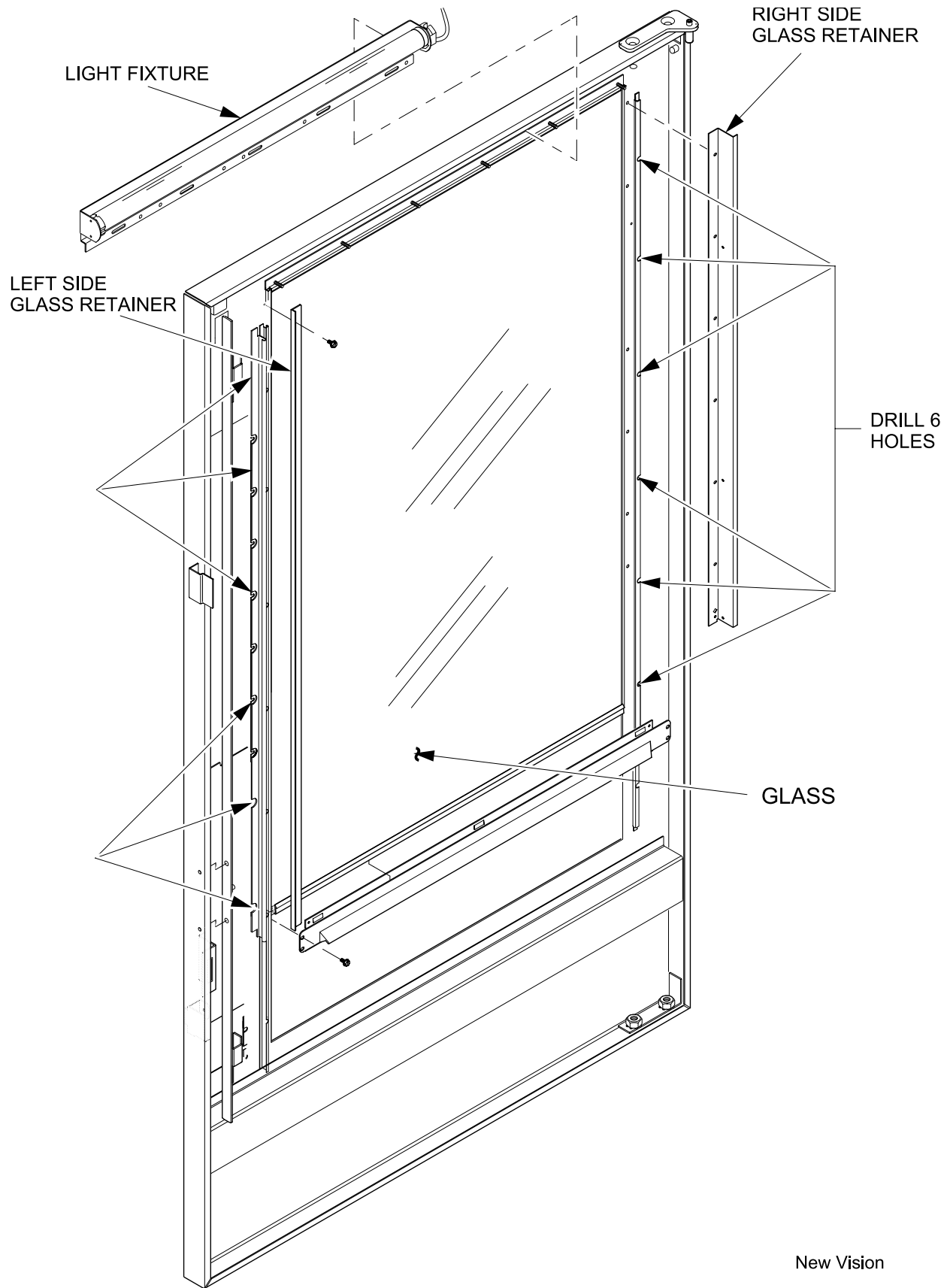

New Vision

Figure 1